

Varenummer: 03445140
Beskrivelse: Fluro Heavy Duty Ledleje GE 140 EW-2RS
Hul Ø140
Note: 140

Mål

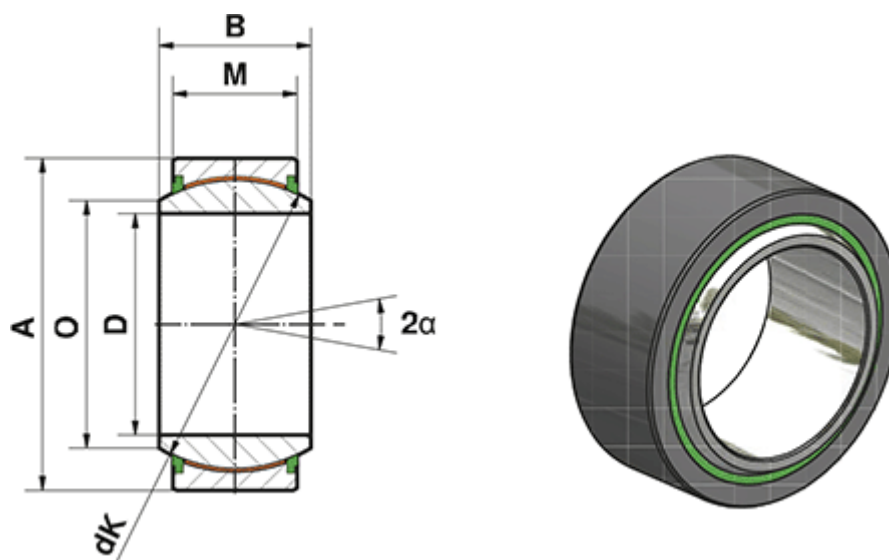

A	= 210
a (grader)	= 7
B	= 90
D	= 140
dK	= 180
Dynamisk belastning C (kN)	= 3015
M	= 70
O	= 155.8

Statisk belastning C0 (kN)	= 5025
Vægt (g)	= 10600